

General Feature

- Absorbent Glass Mat(AGM) technology for efficient gas recombination of up to 99% and freedom from electrolyte maintenance or water adding.
- Not restricted for air transport-complies with IATA/ICAO Special Provision A67.
- UL-recognized component.
- Can be mounted in any orientation.
- Computer designed lead, calcium tin alloy grid for high power density.
- Long service life, float or cyclic applications.
- Maintenance-free operation.
- Low self discharge.



SPECIFICATION

Nominal voltage	12V
Number of cell	6
Length(mm/inch)	79/3.11
Width(mm/inch)	55.5/2.19
Height(mm/inch)	98.5/3.88
Total Height(mm/inch)	104/4.09
Approx. Weight(kg/lbs)	1.2/2.64

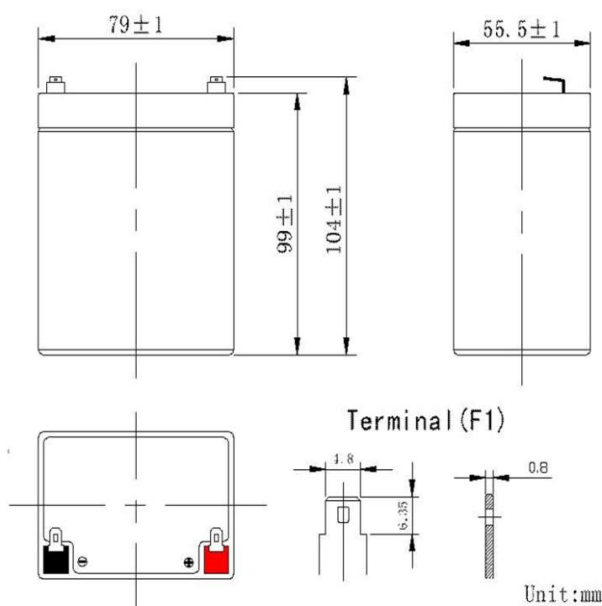

Battery Construction

Component	Positive plate	Negative plate	Container	Cover	Safety valve	Terminal	Separator	Electrolyte
Raw material	Lead dioxide	Lead	ABS	ABS	Rubber	Copper	Fiberglass	Sulfuric acid

Performance Characteristics

Capacity 77°F(25°C)	20 hours rate(0.145A 10.5V)	2.9Ah
	10 hours rate(0.26A 10.5V)	2.6Ah
	5 hours rate(0.51A 10.5V)	2.55Ah
	1 hour rate(2.1A 9.6V)	2.1Ah
Internal Resistance	Full charged battery 77°F(25°C):40mΩ	
Capacity affected by Temperature (20 hour rate)	104°F(40°C)	102%
	77°F(25°C)	100%
	32°F(10°C)	85%
	5°F(-15°C)	65%
Self-Discharge 68°F(20°C)	Capacity after 3 month storage	90%
	Capacity after 6 month storage	80%
	Capacity after 12 month storage	60%
Max discharge current 77°F(25°C):43.5A(5S)		
Charge (Constant Voltage)	Float:13.6 to 13.8V/77°F/(25°C)	
	Cycle:14.5 to 14.9V/77°F/(25°C)	
	Max Current:0.73A	

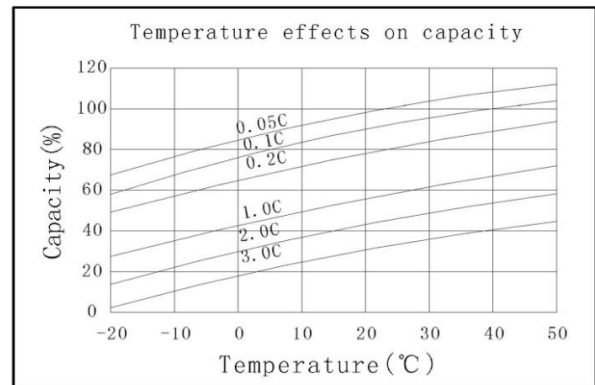
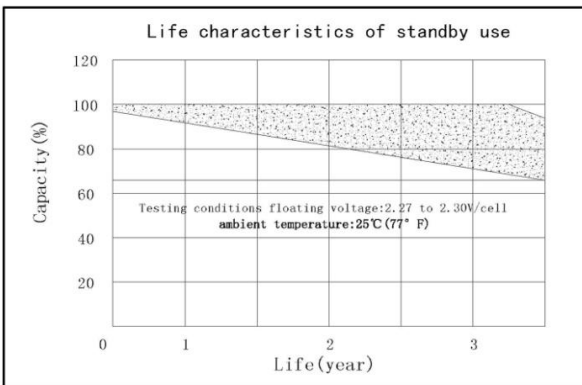
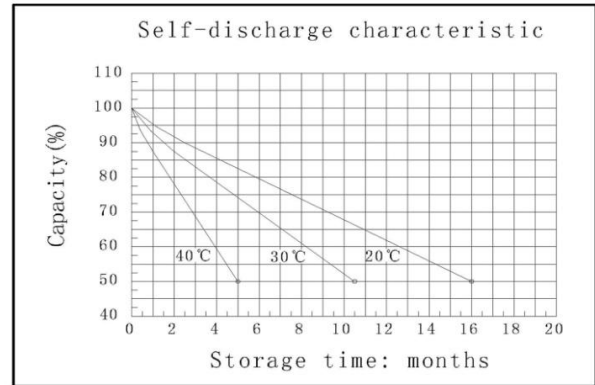
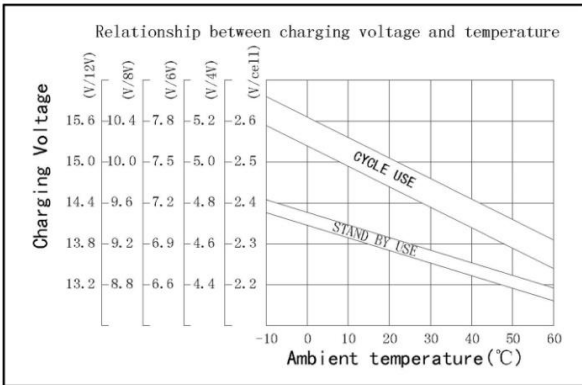
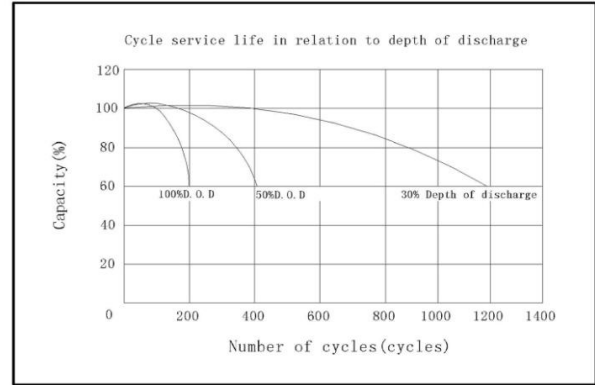
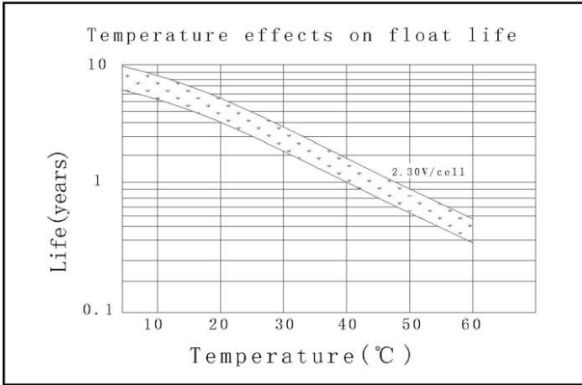
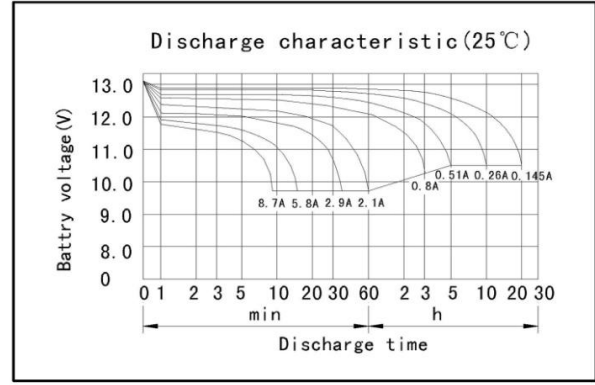
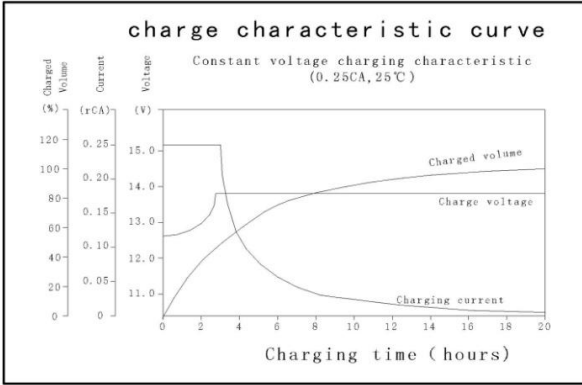

Discharge Constant Current (Amperes at 77°F 25°C)

End Point Volts/Cell	5min	10min	15min	30min	1h	3h	5h	10h	20h
1.60V	13.5	8.80	6.95	4.00	2.10	0.85	0.55	0.29	0.155
1.65V	12.9	8.45	6.70	3.86	2.02	0.83	0.54	0.28	0.155
1.70V	12.2	8.07	6.43	3.71	1.93	0.80	0.53	0.27	0.150
1.75V	11.4	7.67	6.15	3.56	1.84	0.77	0.51	0.26	0.145
1.80V	10.5	7.20	5.85	3.40	1.74	0.73	0.49	0.24	0.140

(Note)The above characteristics data are average values obtained Within three charge/discharge cycles not the minimum values.

Discharge Constant Power (watts at 77°F 25°C)

End Point Volts/Cell	5min	10min	15min	30min	45min	1h	2h	3h	5h
1.60V	26.6	17.3	13.9	8.35	6.00	4.58	2.63	1.77	1.18
1.65V	25.4	16.6	13.5	8.08	5.80	4.44	2.56	1.73	1.16
1.70V	24.1	15.8	13.0	7.79	5.58	4.29	2.48	1.68	1.13
1.75V	22.7	14.9	12.5	7.50	5.36	4.14	2.40	1.63	1.10
1.80V	21.2	13.9	11.9	7.20	5.11	3.97	2.31	1.57	1.06

(Note)The above characteristics data are average values obtained Within three charge/discharge cycles not the minimum values.